

EVOLUTIONDRIVE 82

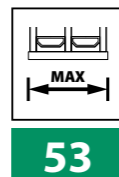
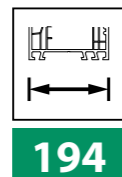
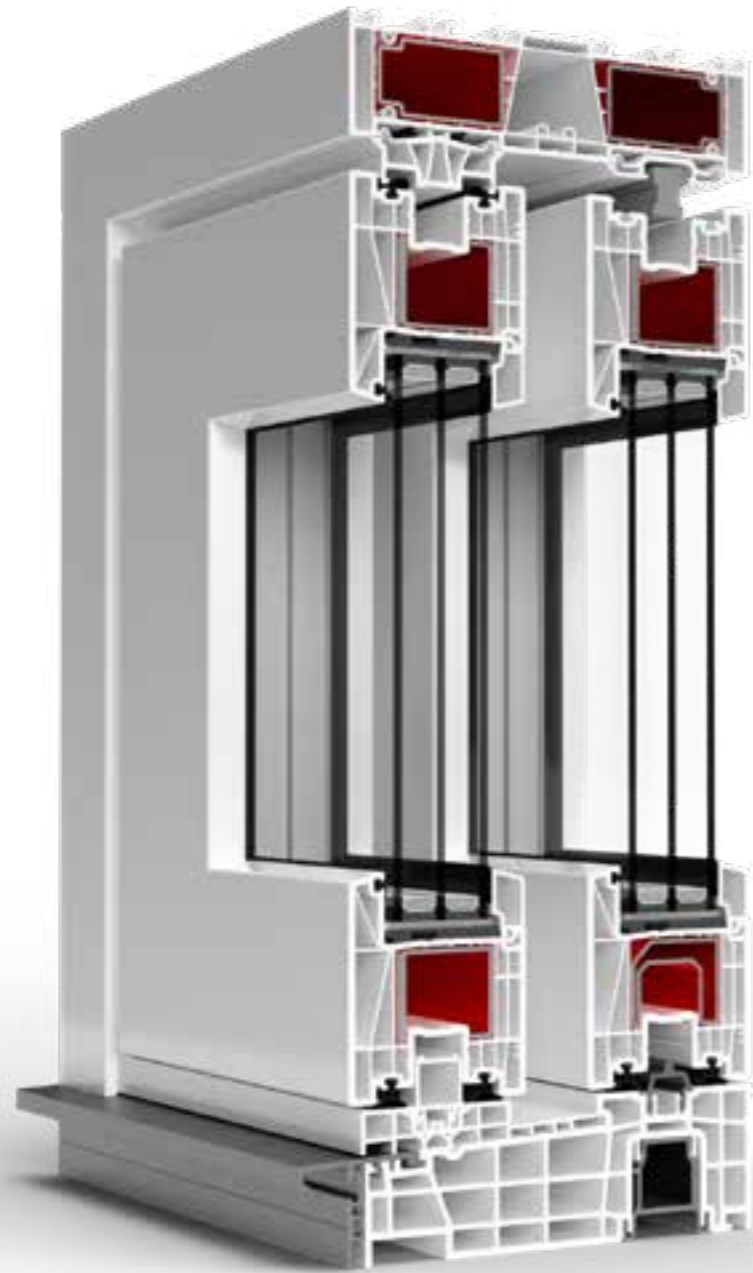

EVOLUTIONDRIVE SF

EVOLUTIONDRIVE 82

EVOLUTIONDRIVE SF

EVOLUTIONDRIVE 82

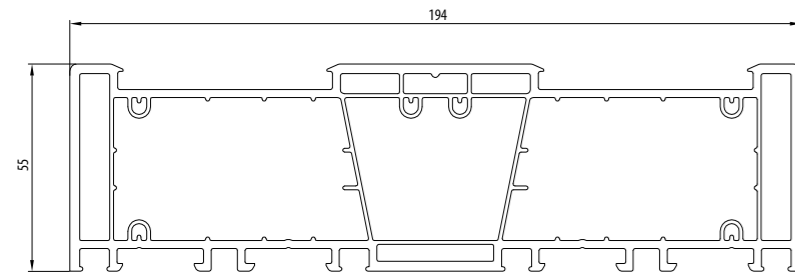

H8050

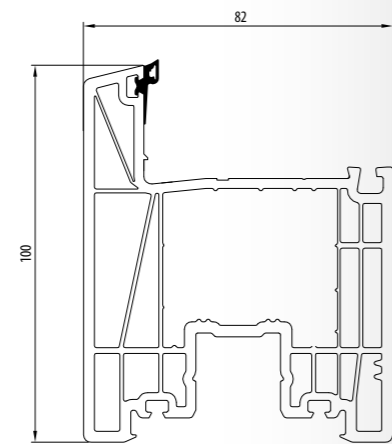

H8600

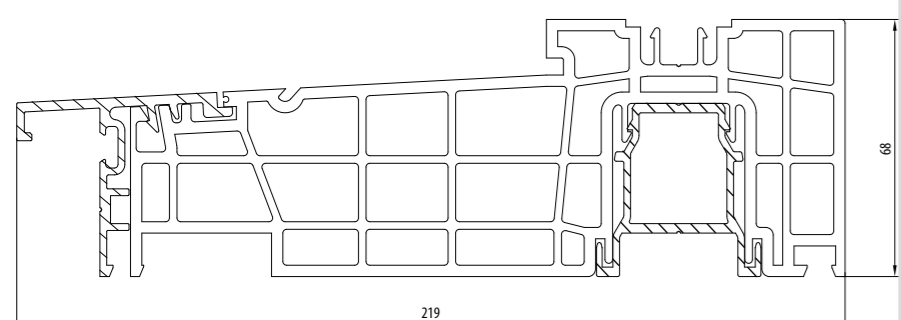

Thermostep

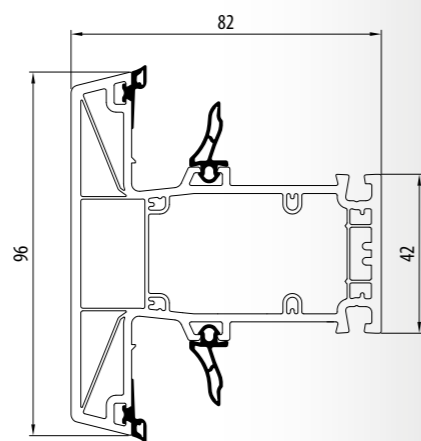



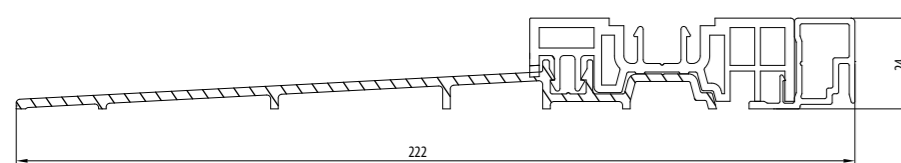

HO9310

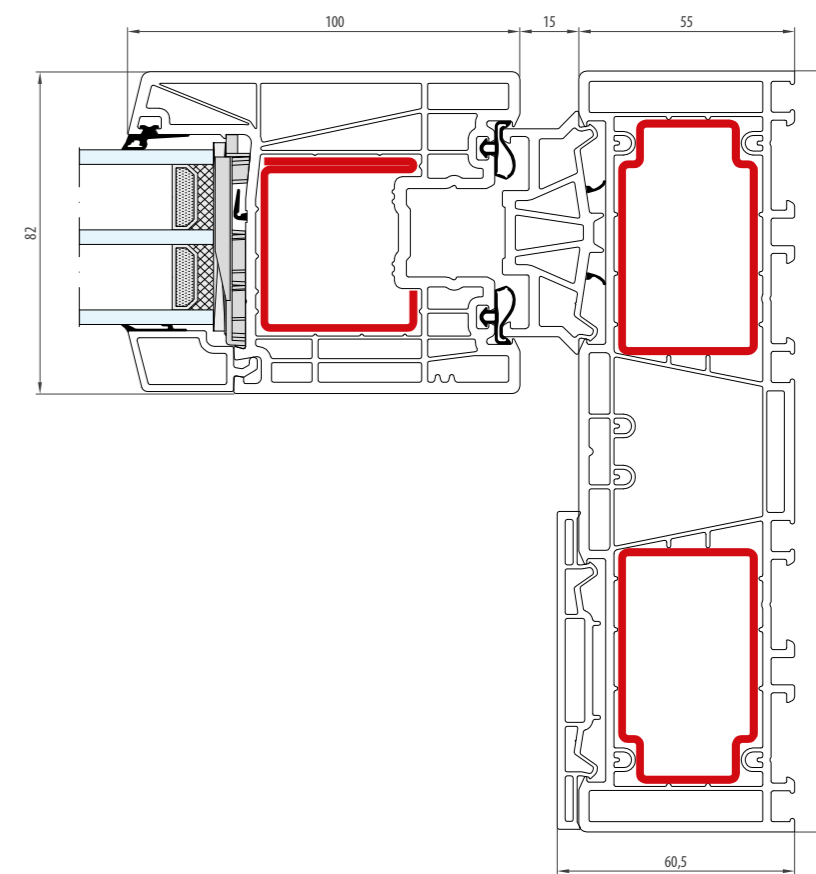
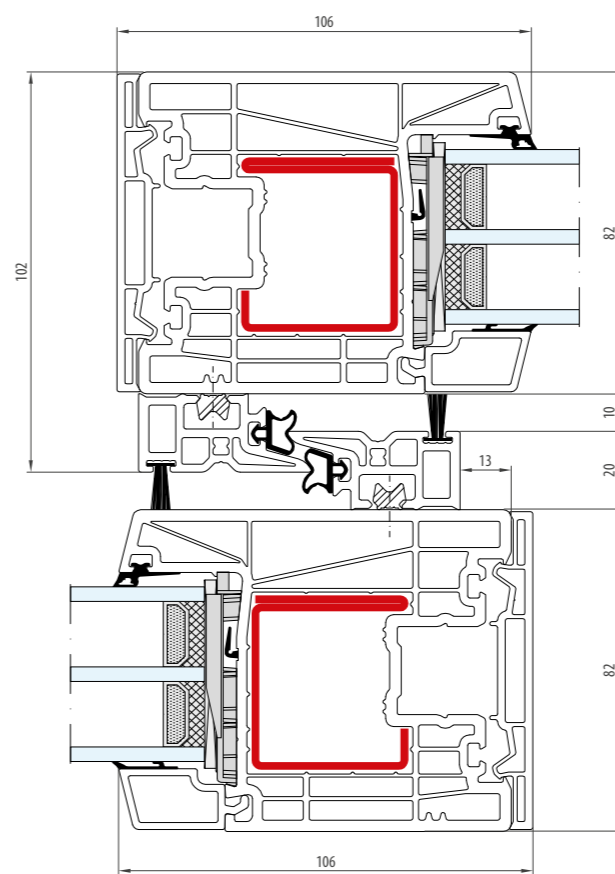
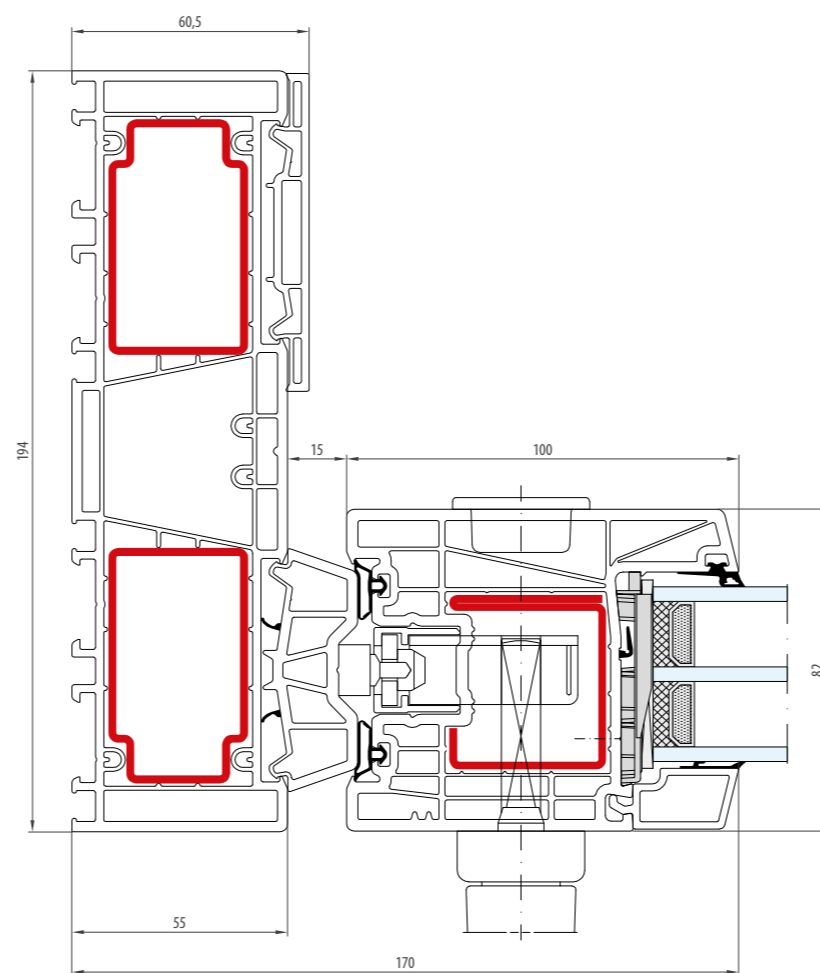

Flatstep



-  Schemat A - Przekrój poziomy - Rama: 55 mm · Skrzydło: 100 mm
-  Schéma A - Coupe horizontale - Dormant: 55 mm · Vantail: 100 mm
-  Schema A - Doorsnede horizontaal - Frame: 55 mm · Sash: 100 mm
-  Schema A - Wagerechter Schnitt - Rahmen: 55 mm · Flügel: 100 mm
-  Schema A - Sezione orizzontale - Telaio: 55 mm · Anta: 100 mm

1:2

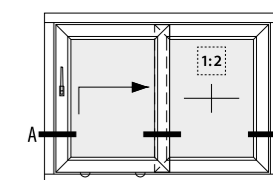

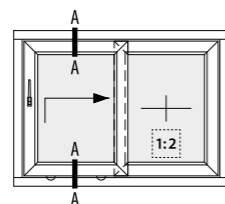
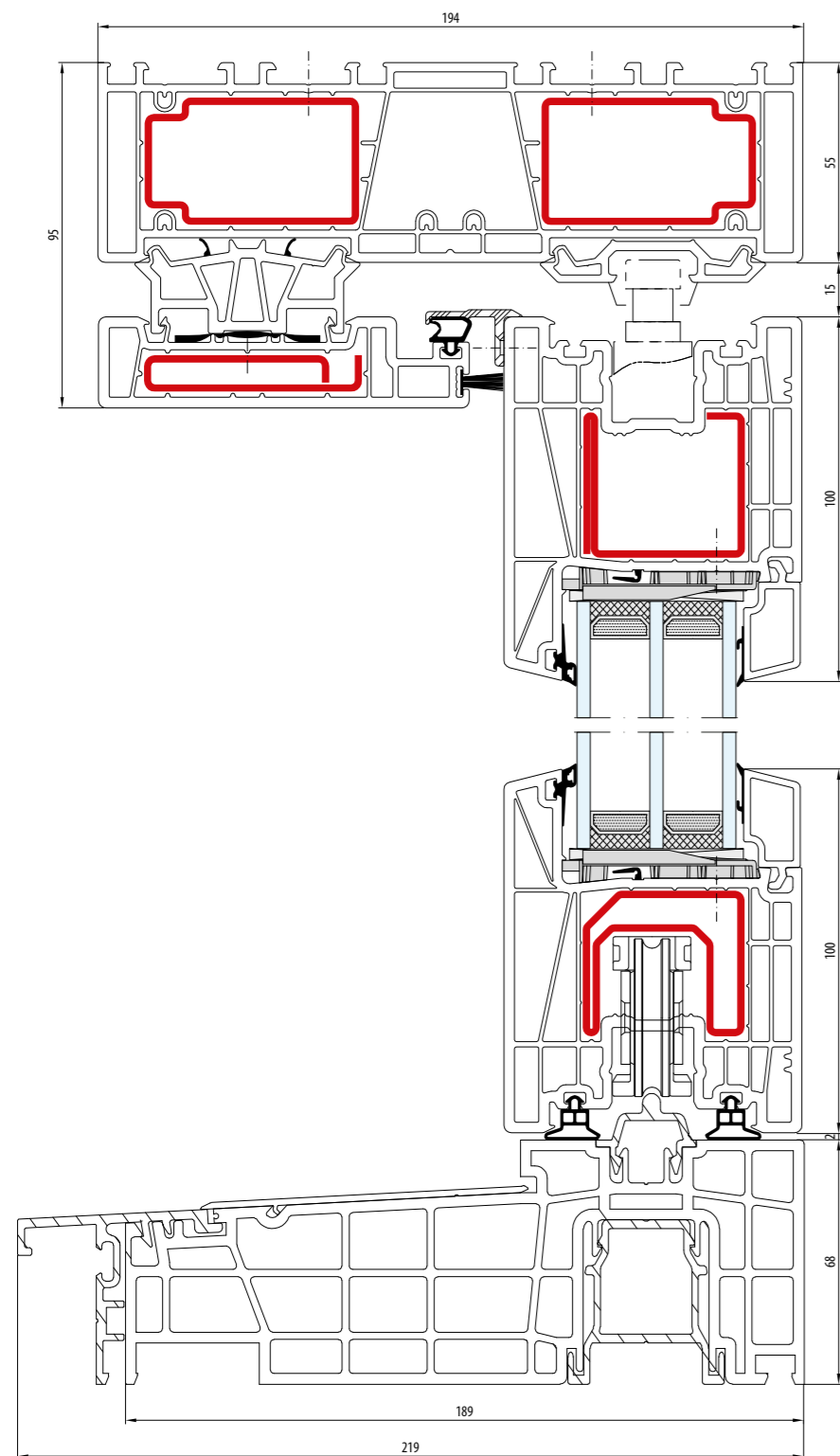

- Schemat A - Przekrój pionowy · Próg: 68 mm · Skrzydło: 100 mm
- Schéma A - Coupe verticale · Seuil: 68 mm · Vantail: 100 mm
- Schema A - Doorsnede verticaal · Doorstep: 68 mm · Sash: 100 mm
- Schema A - Senkrechter Schnitt · Schwelle: 68 mm · Flügel: 100 mm
- Schema A - Sezione verticale · Soglia: 68 mm · Anta: 100 mm

EVOLUTIONDRIVE SF

EVOLUTIONDRIVE 82

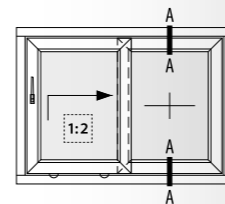
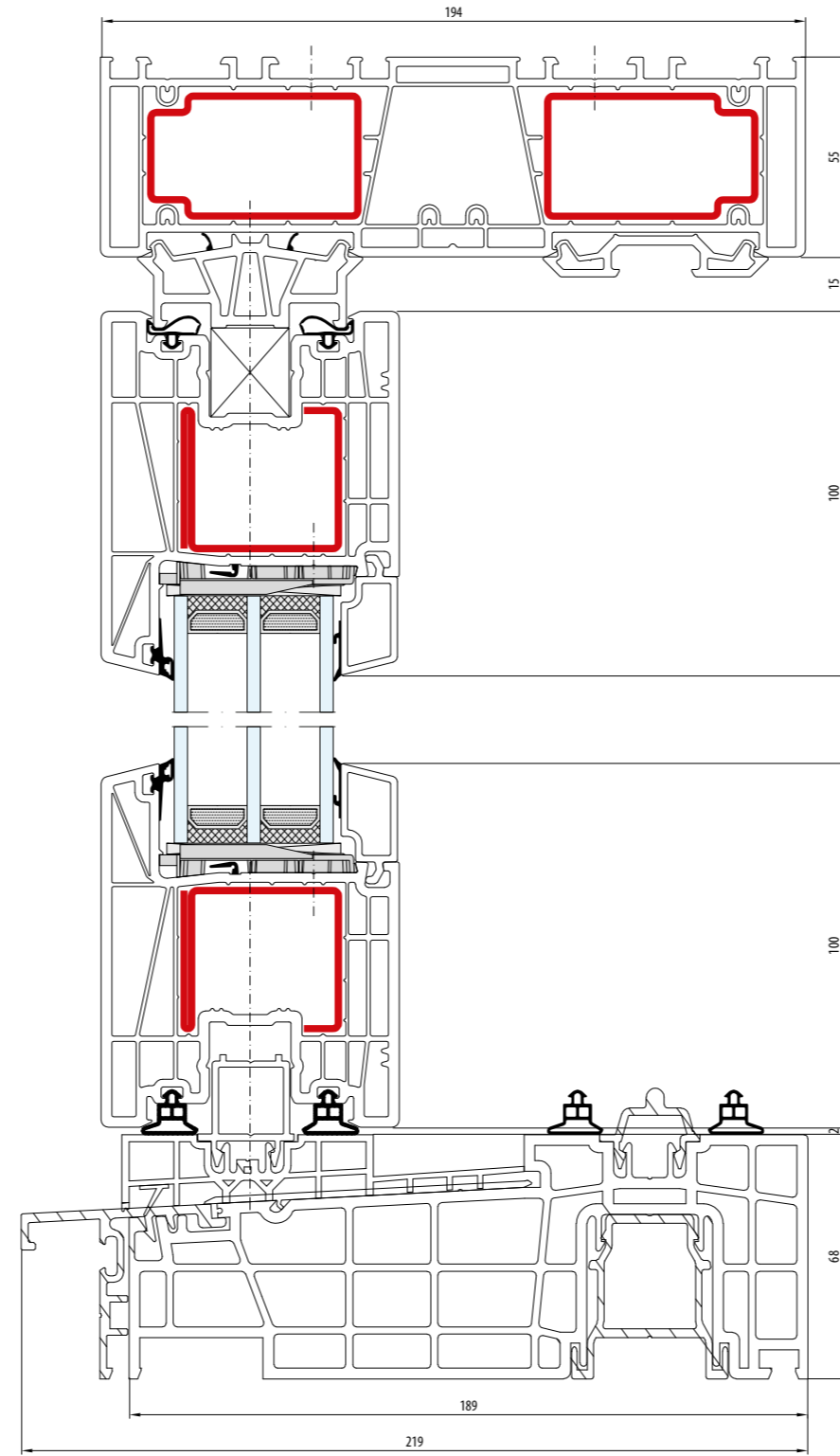

- Schemat A - Przekrój pionowy · Próg: 68 mm · Skrzydło: 100 mm
- Schéma A - Coupe verticale · Seuil: 68 mm · Vantail: 100 mm
- Schema A - Doorsnede verticaal · Doorstep: 68 mm · Sash: 100 mm
- Schema A - Senkrechter Schnitt · Schwelle: 68 mm · Flügel: 100 mm
- Schema A - Sezione verticale · Soglia: 68 mm · Anta: 100 mm

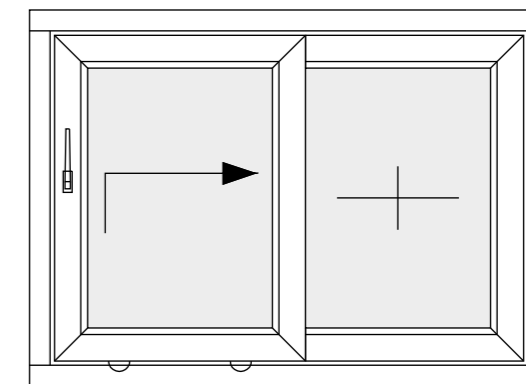

A

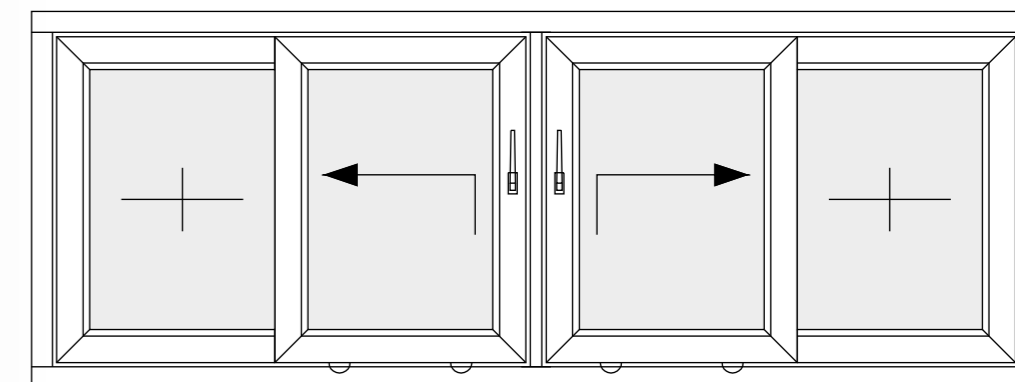

C

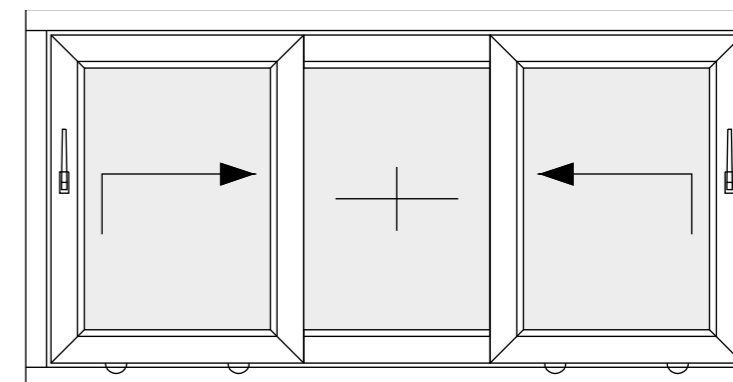

K

- Schemat
- Schéma
- Schema
- Schema
- Schema

EVOLUTIONDRIVE SF

EVOLUTIONDRIVE 82