

HST EKOSUN

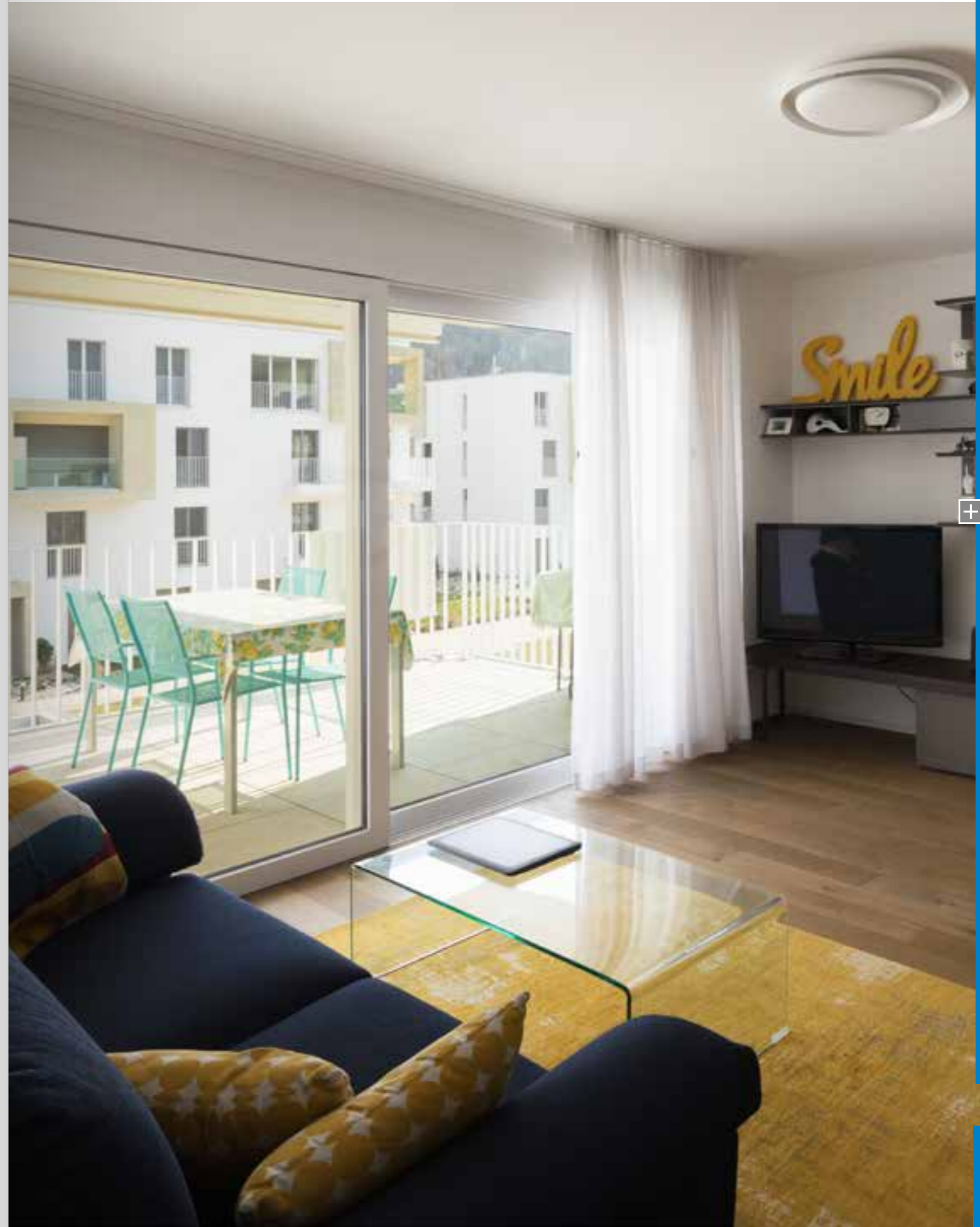

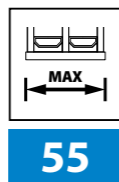

8510

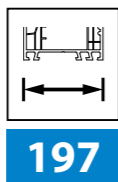
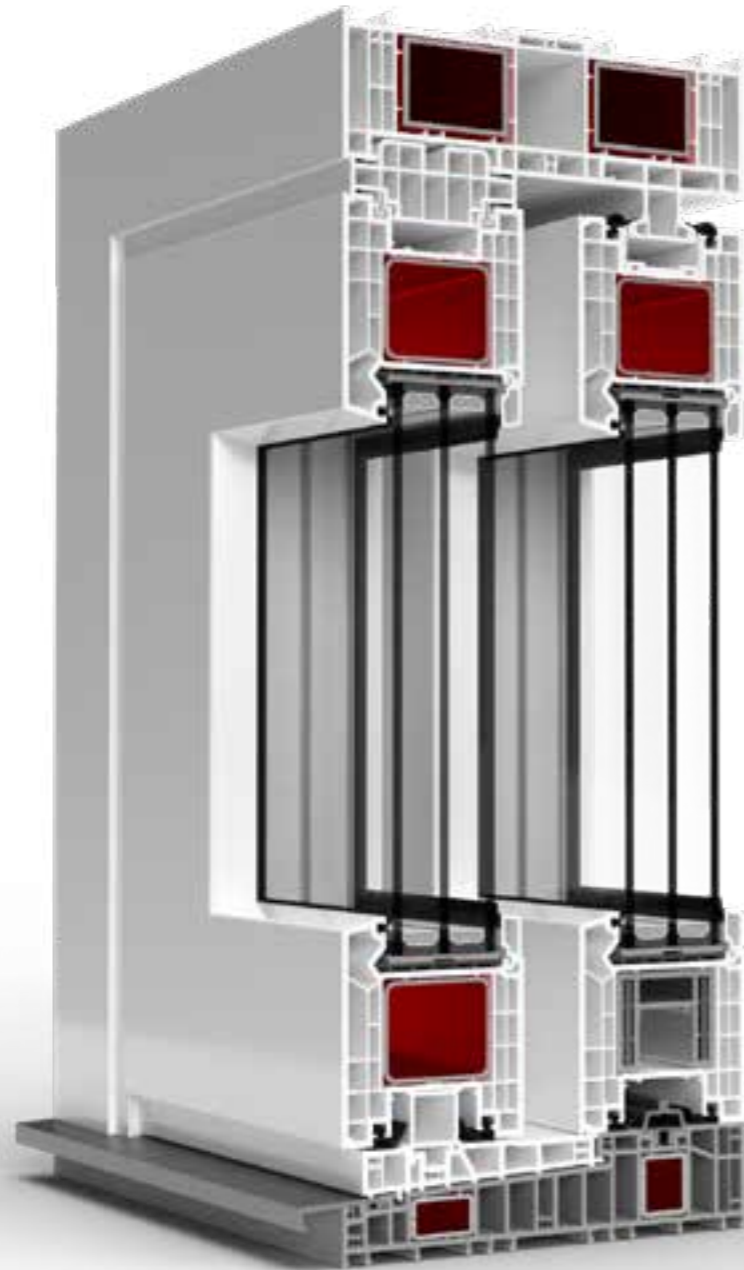
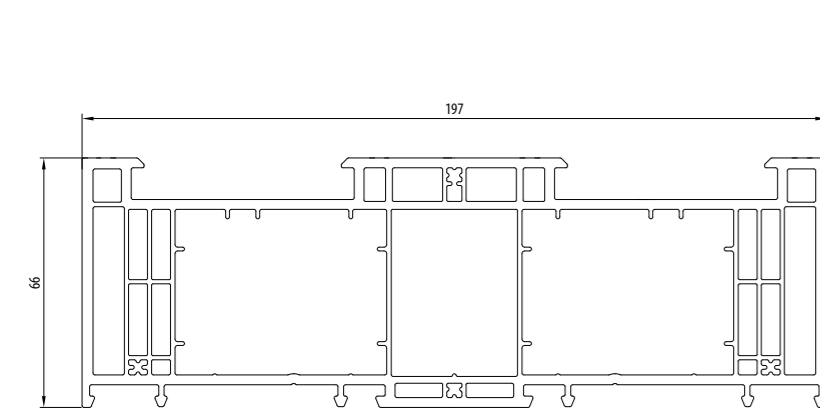
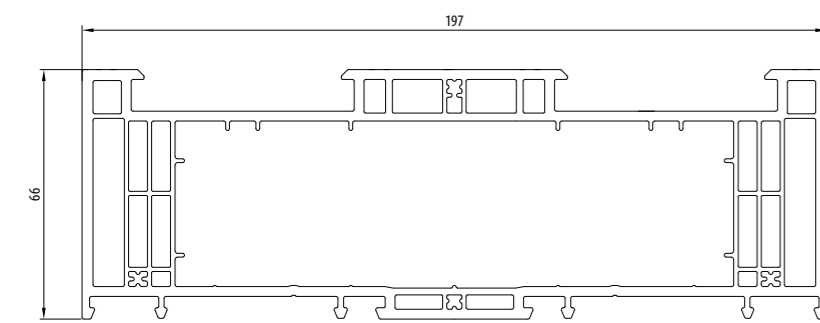

8511

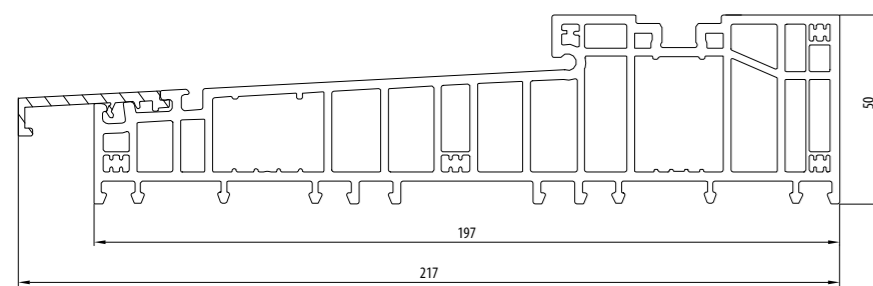

Inspiro

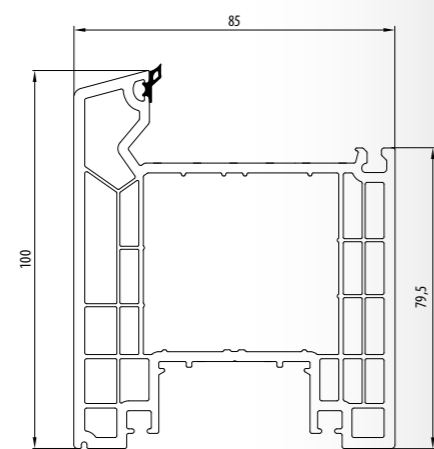

8520

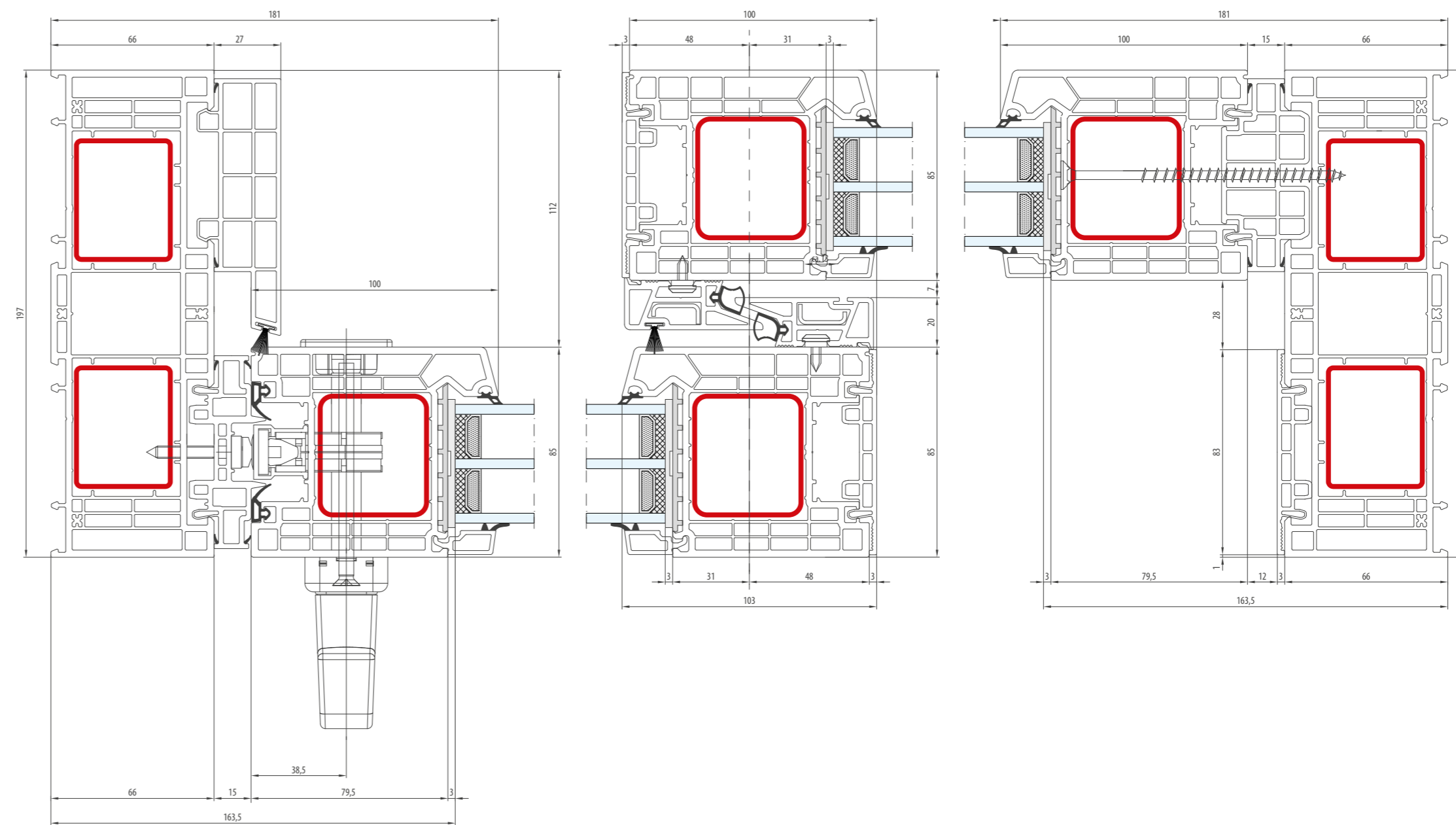

- Schemat A - Przekrój poziomy · Rama: 66 mm · Skrzydło: 100 mm
- Schéma A - Coupe horizontale · Dormant: 66 mm · Vantail: 100 mm
- Schema A - Doorsnede horizontaal · Frame: 66 mm · Sash: 100 mm
- Schema A - Wagerechter Schnitt · Rahmen: 66 mm · Flügel: 100 mm
- Schema A - Sezione orizzontale · Telaio: 66 mm · Anta: 100 mm

1:2

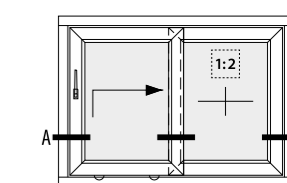

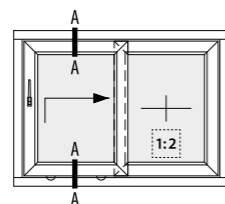
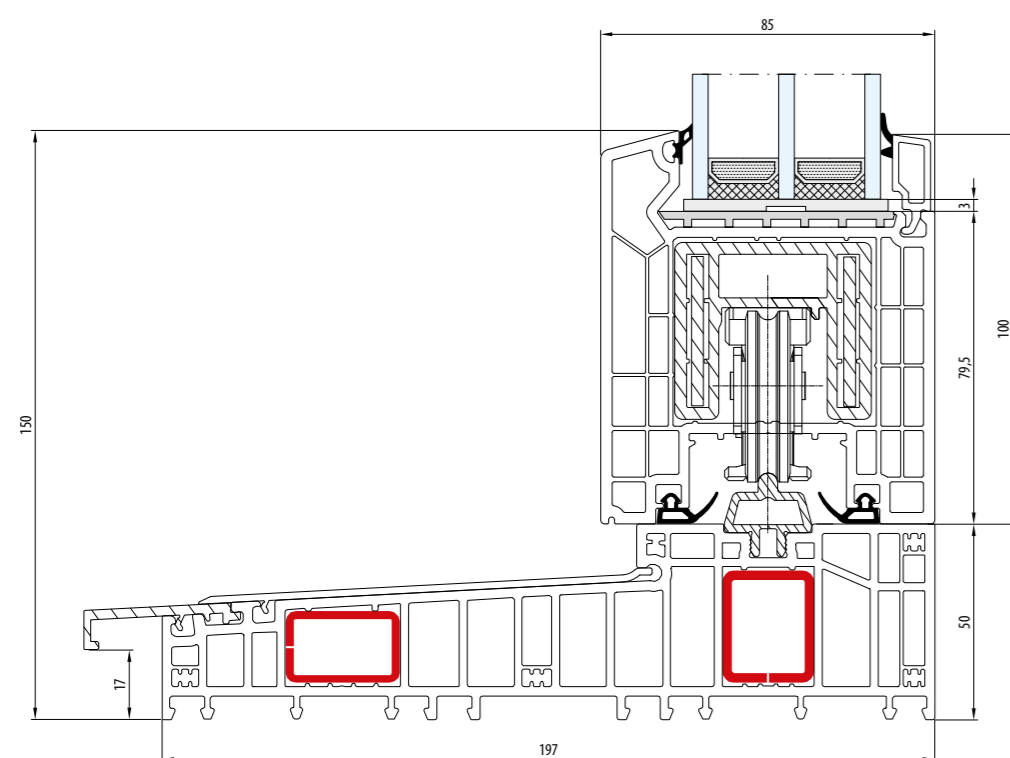
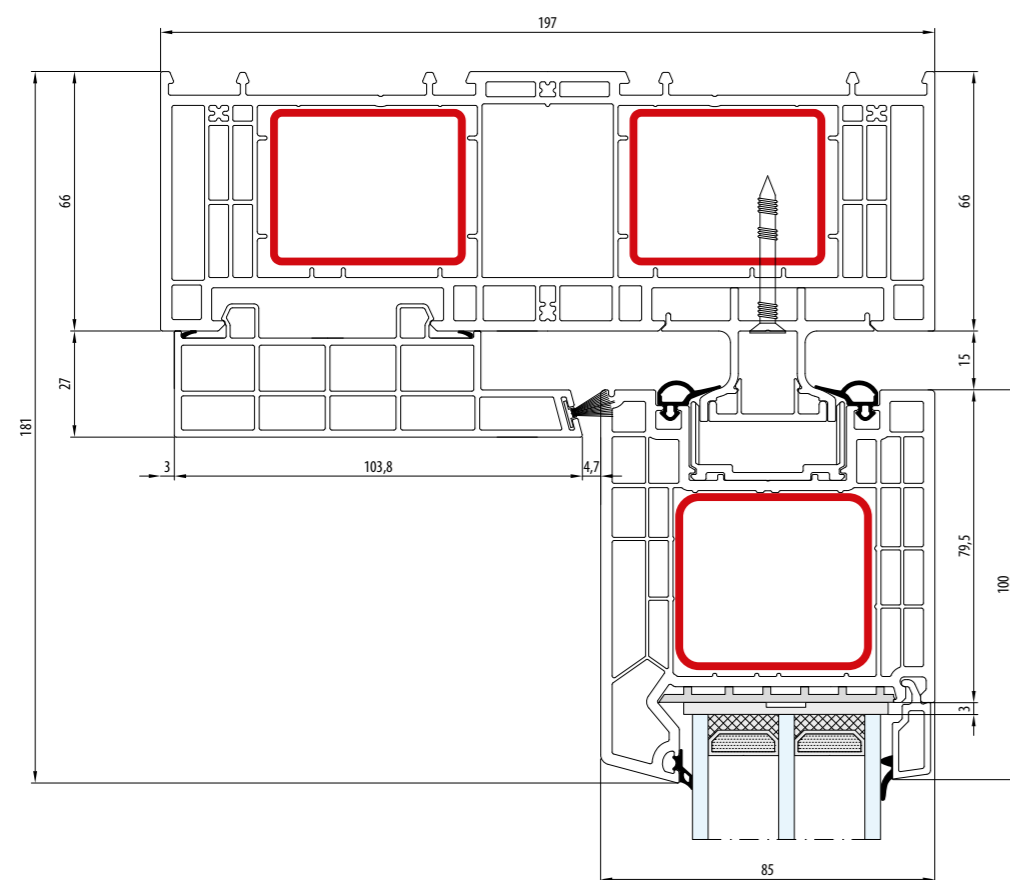

- Schemat A - Przekrój pionowy · Próg: 50 mm · Skrzydło: 100 mm
- Schéma A - Coupe verticale · Seuil: 50 mm · Vantail: 100 mm
- Schema A - Doorsnede verticaal · Doorstep: 50 mm · Sash: 100 mm
- Schema A - Senkrechter Schnitt · Schwelle: 50 mm · Flügel: 100 mm
- Schema A - Sezione verticale · Soglia: 50 mm · Anta: 100 mm

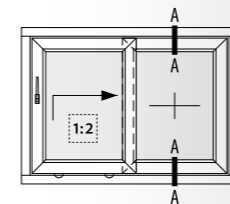
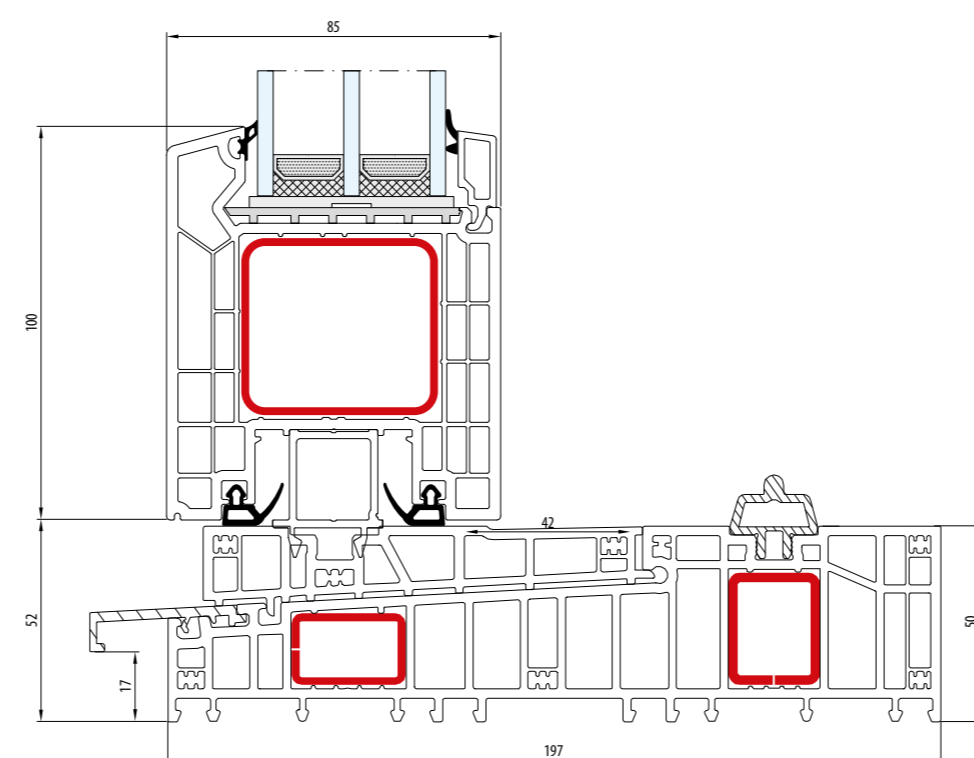
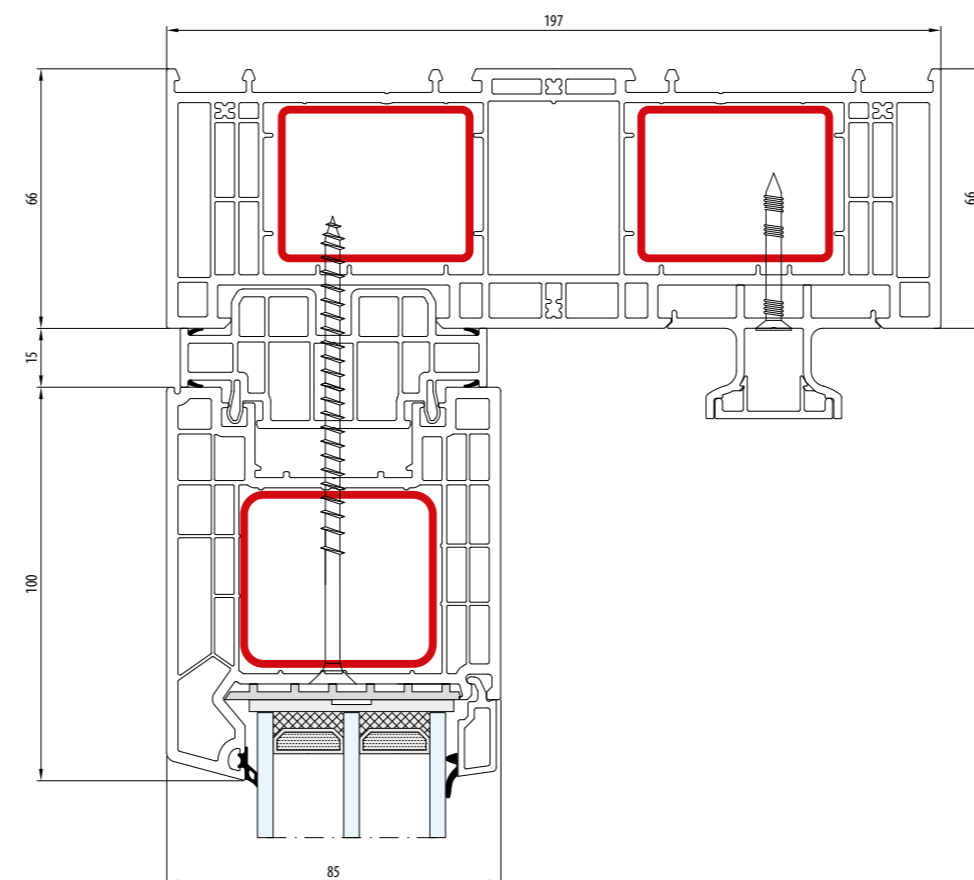

- Schemat A - Przekrój pionowy · Próg: 50 mm · Skrzydło: 100 mm
- Schéma A - Coupe verticale · Seuil: 50 mm · Vantail: 100 mm
- Schema A - Doorsnede verticaal · Doorstep: 50 mm · Sash: 100 mm
- Schema A - Senkrechter Schnitt · Schwelle: 50 mm · Flügel: 100 mm
- Schema A - Sezione verticale · Soglia: 50 mm · Anta: 100 mm

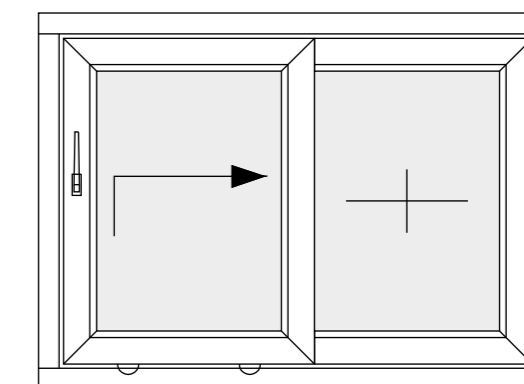

A

- Schemat
- Schéma
- Schema
- Schema
- Schema