

HST 85

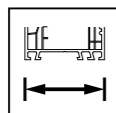

197

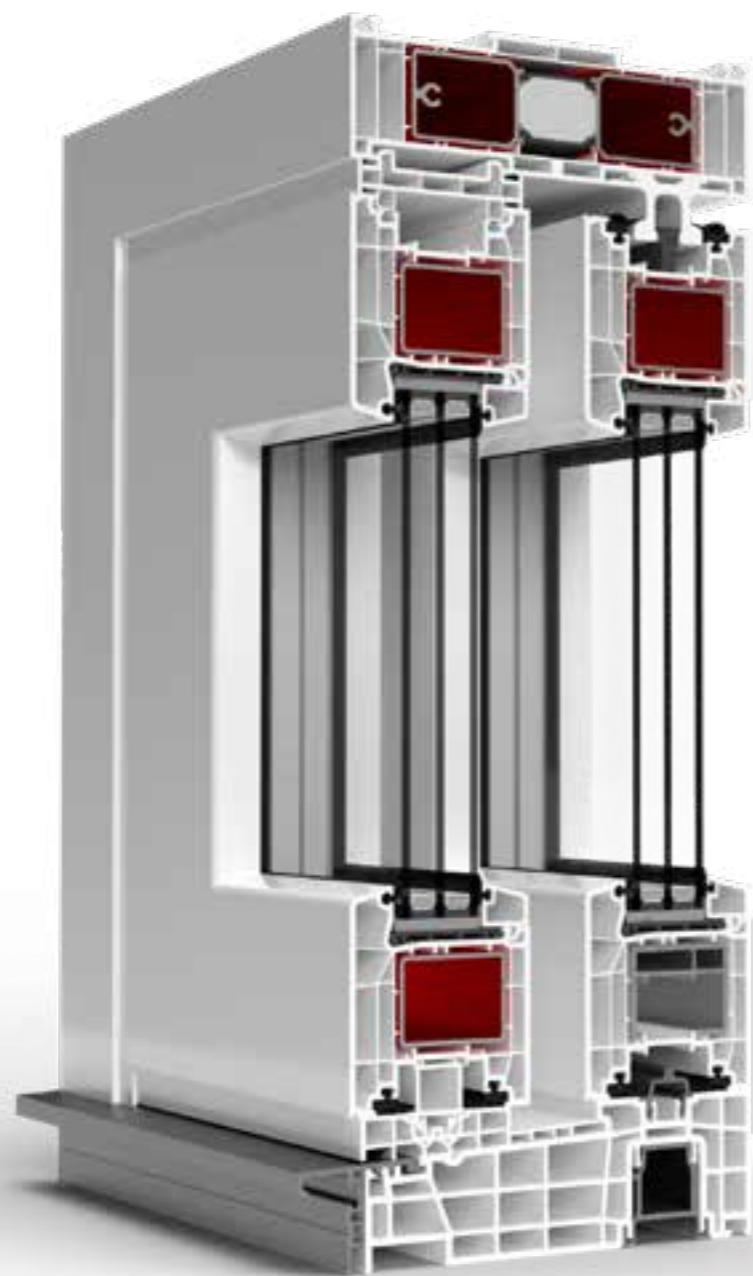
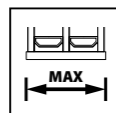

52

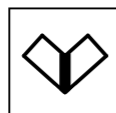

V SUPER SOLUTION



ALU



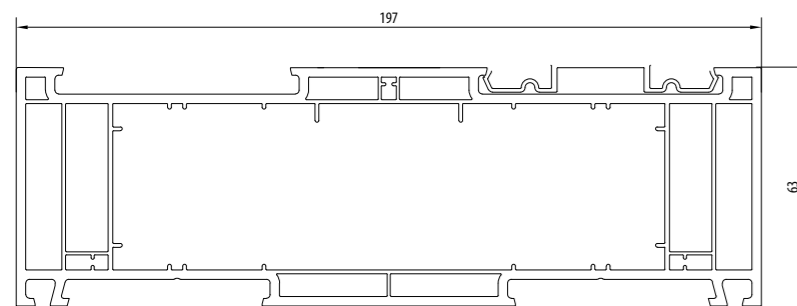

170x80

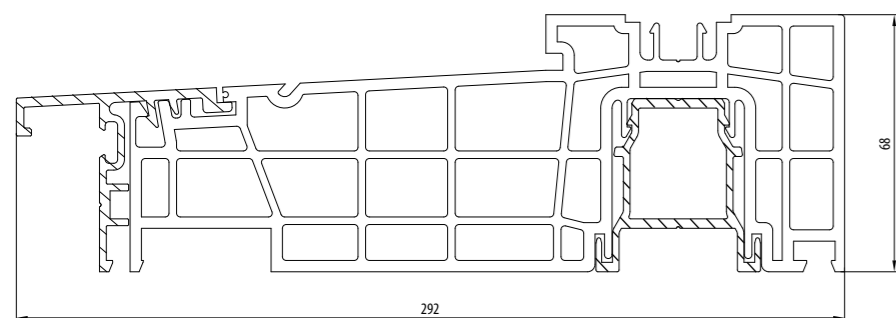

Thermostep

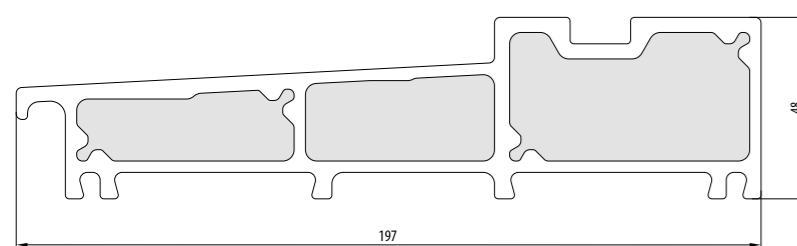

Premium

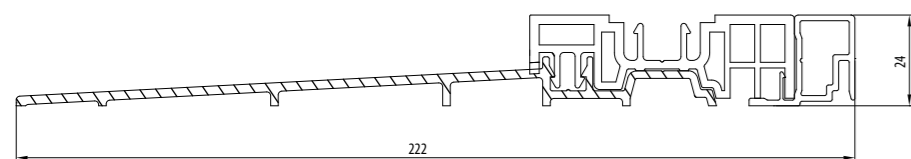

Flatstep

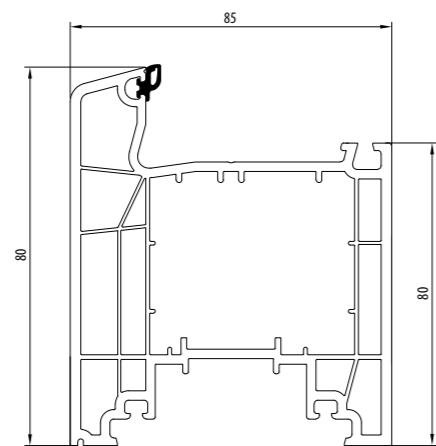

170x81

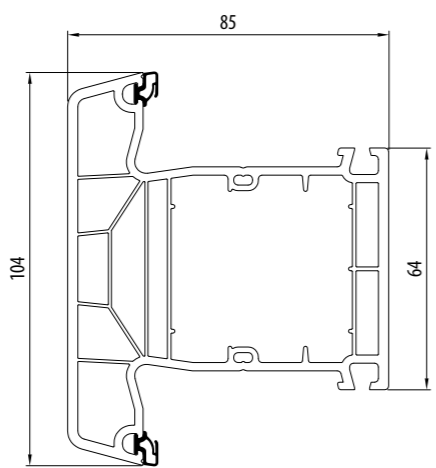

170x44

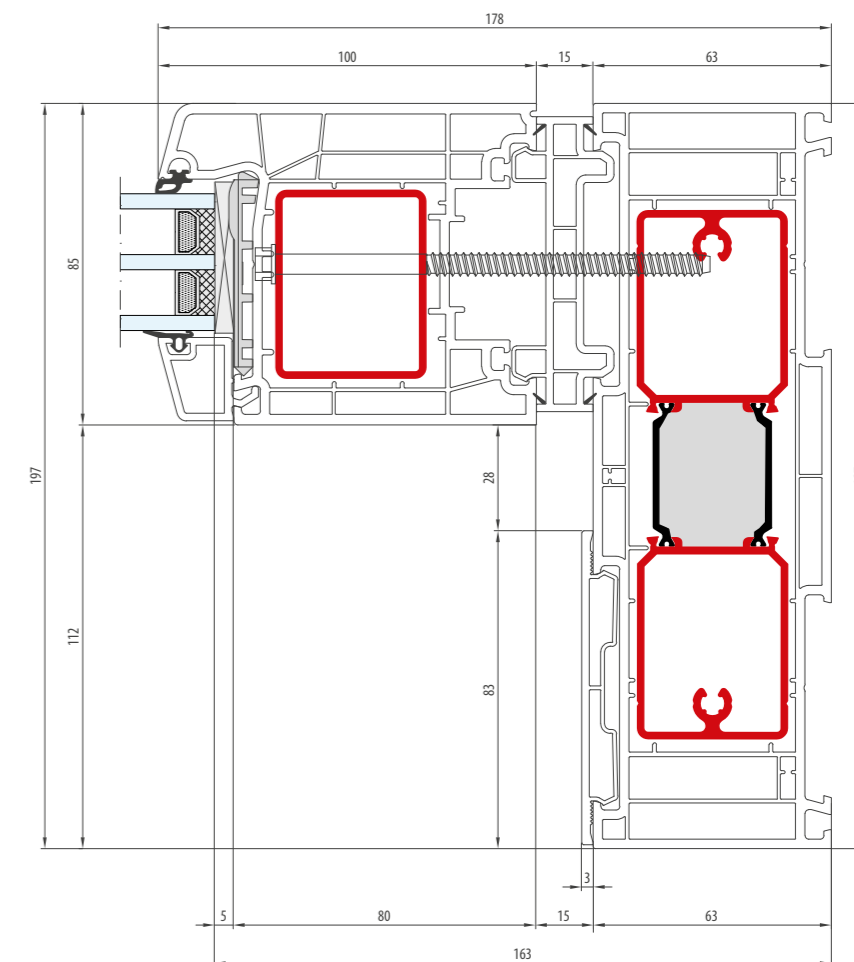
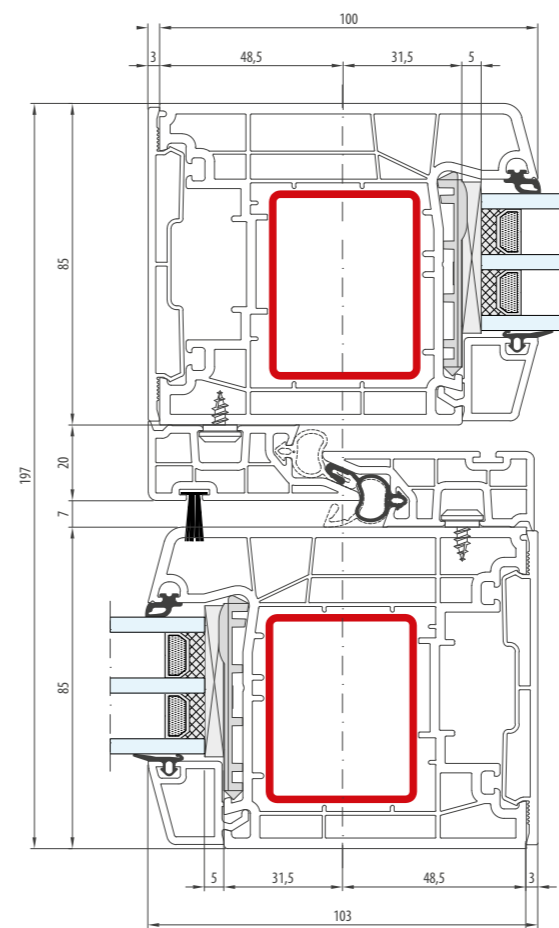
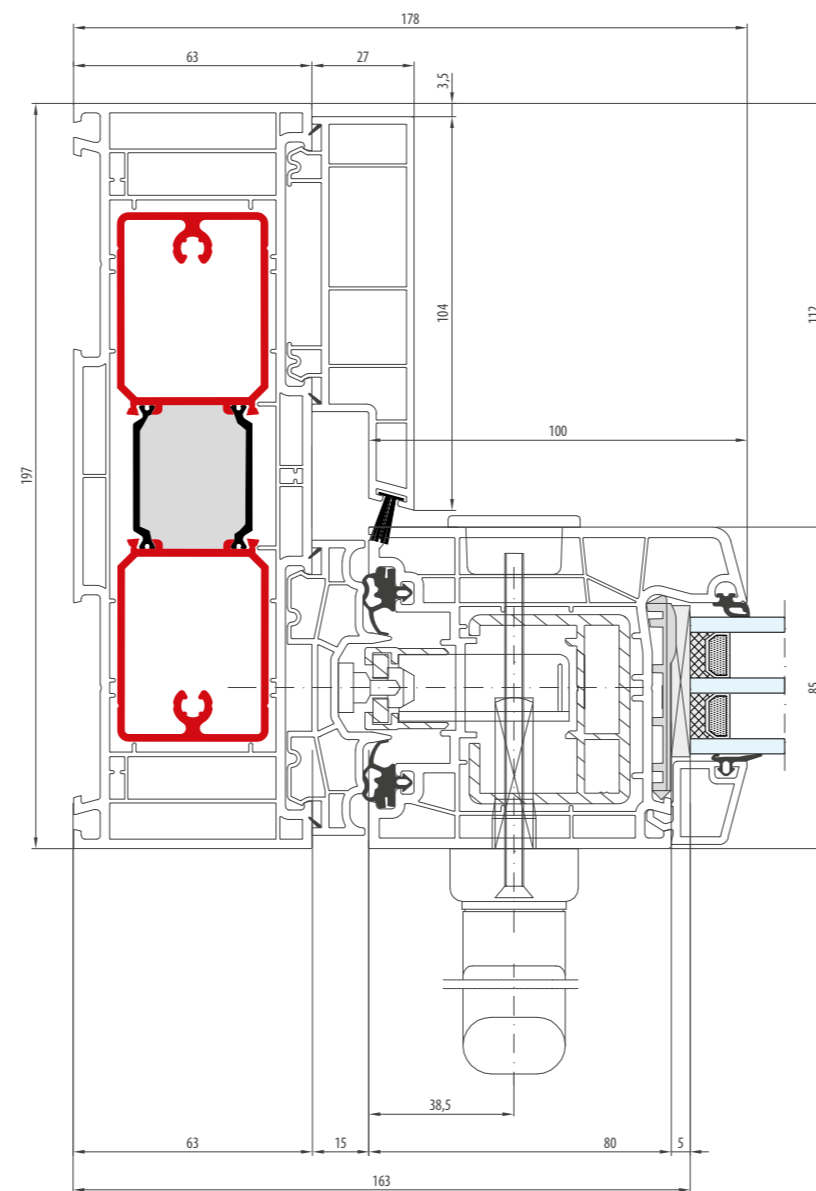

- Schemat A - Przekrój poziomy - Rama: 63 mm · Skrzydło: 100 mm
- Schéma A - Coupe horizontale - Dormant: 63 mm · Vantail: 100 mm
- Schema A - Doorsnede horizontaal - Frame: 63 mm · Sash: 100 mm
- Schema A - Wagerechter Schnitt - Rahmen: 63 mm · Flügel: 100 mm
- Schema A - Sezione orizzontale - Telaio: 63 mm · Anta: 100 mm

1:2

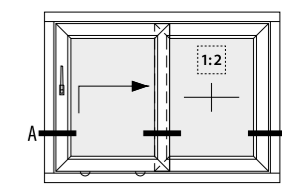

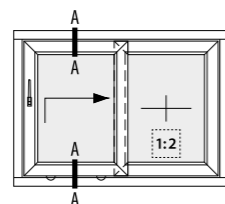
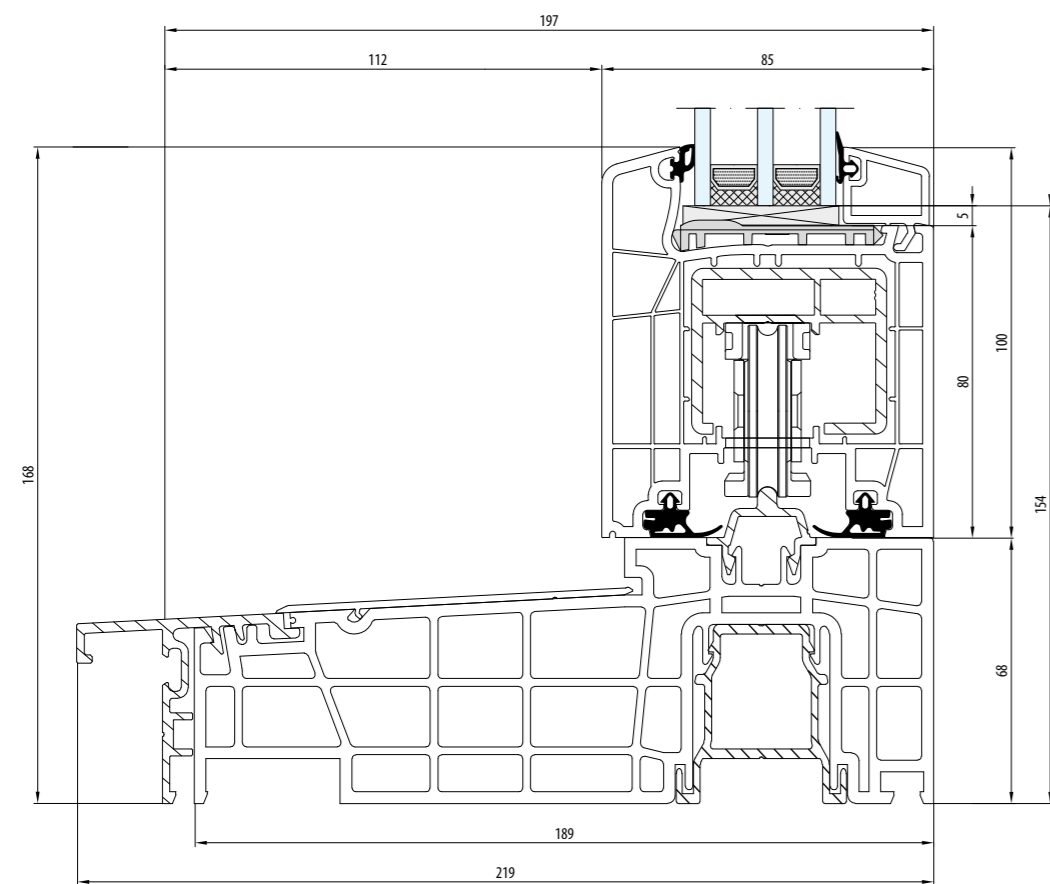
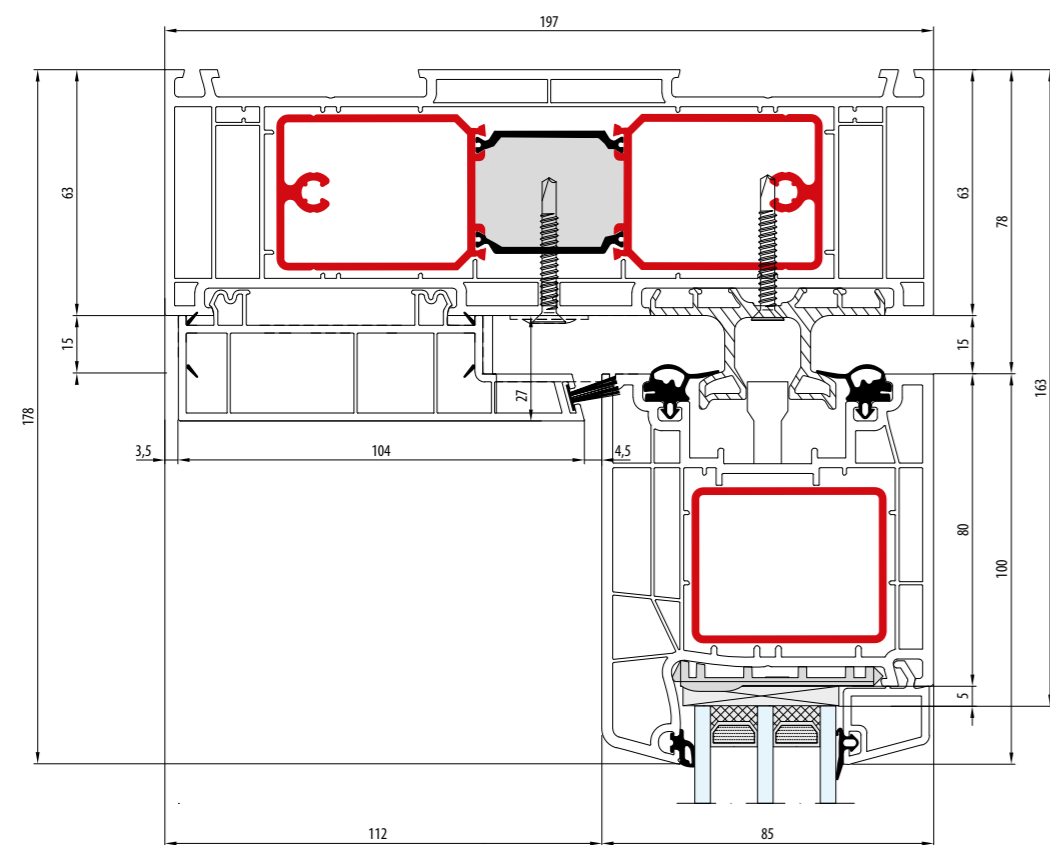

- Schemat A - Przekrój pionowy · Próg: 68 mm · Skrzydło: 100 mm
- Schéma A - Coupe verticale · Seuil: 68 mm · Vantail: 100 mm
- Schema A - Doorsnede verticaal · Doorstep: 68 mm · Sash: 100 mm
- Schema A - Senkrechter Schnitt · Schwelle: 68 mm · Flügel: 100 mm
- Schema A - Sezione verticale · Soglia: 68 mm · Anta: 100 mm

EASY SLIDE

MULTI SLIDE

SMART SLIDE

HST 70

HST 85

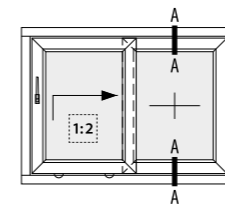
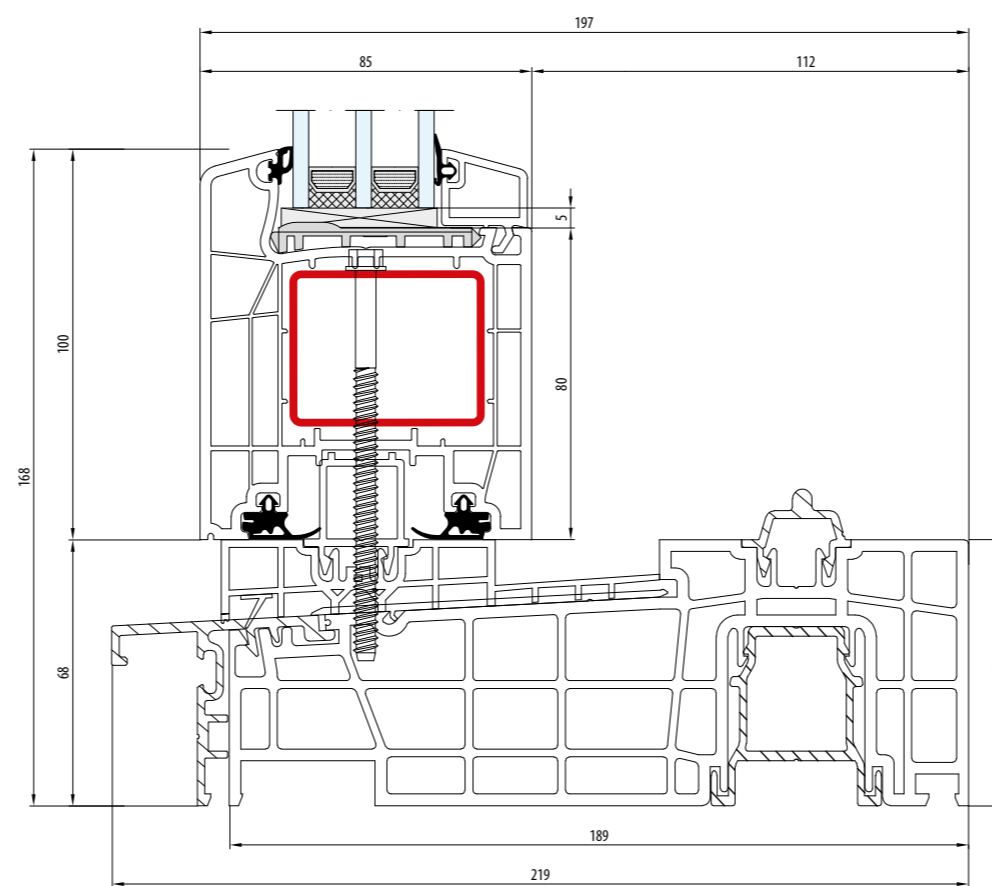
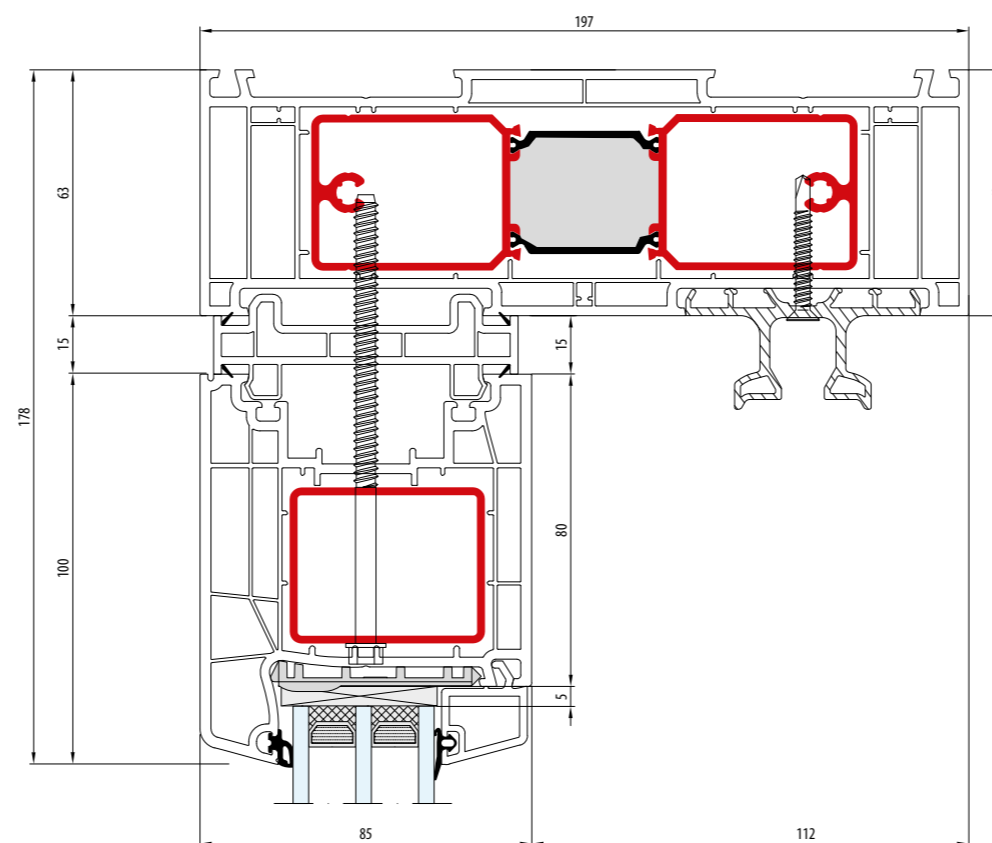

- Schemat A - Przekrój pionowy · Próg: 68 mm · Skrzydło: 100 mm
- Schéma A - Coupe verticale · Seuil: 68 mm · Vantail: 100 mm
- Schema A - Doorsnede verticaal · Doorstep: 68 mm · Sash: 100 mm
- Schema A - Senkrechter Schnitt · Schwelle: 68 mm · Flügel: 100 mm
- Schema A - Sezione verticale · Soglia: 68 mm · Anta: 100 mm



- Schemat
- Schéma
- Schema
- Schema
- Schema

EASY SLIDE

MULTI SLIDE

SMART SLIDE

HST 70

HST 85

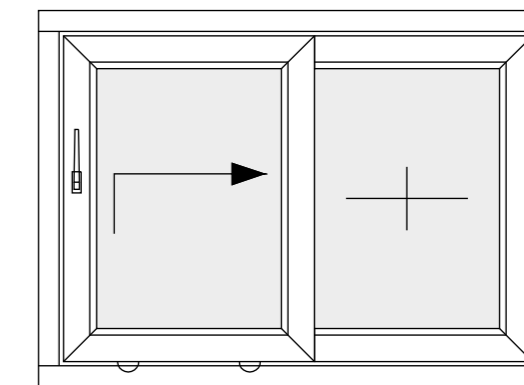

A

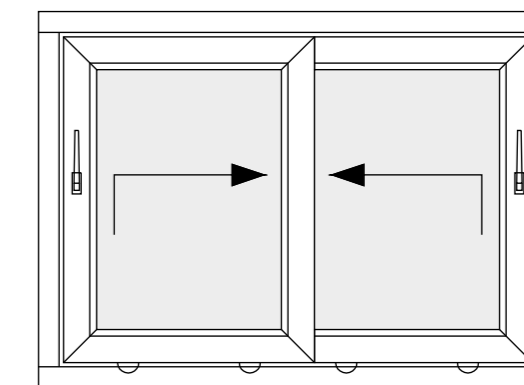

D

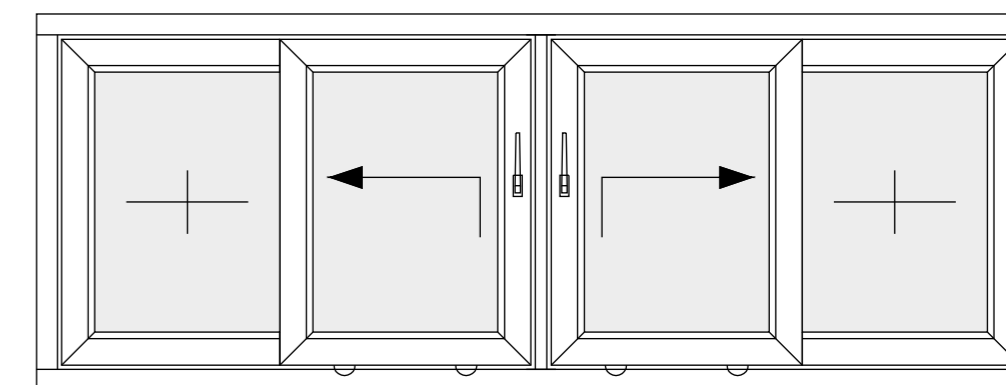

C